



Shipping & Mailing
Inserter

Vertical Power Stacker

for Relay™ Systems

Operator Guide

International English Version

SV61322 Rev. E

October 1, 2015



NOTE: This equipment has been tested and found to comply with the limits for a Class A digital device, pursuant to part 15 of the FCC Rules. These limits are designed to provide reasonable protection against interference when the equipment is operated in a commercial environment. This equipment generates, uses, and can radiate radio frequency energy and, if not installed and used in accordance with the instruction manual, may cause interference to radio communications. Operation of this equipment in a residential area is likely to cause interference in which case the user will be required to correct the interference at his own expense.

CAUTION: Changes or modifications to this equipment not expressly approved by the party responsible for compliance could void the user's authority to operate the equipment.



It is certified that this system complies with all applicable Directives of the European Union.

SV61322 Rev. E October 1, 2015

©2004, 2005, 2006, 2015 Pitney Bowes Inc. All rights reserved.

This book may not be reproduced in whole or in part in any fashion or stored in a retrieval system of any type or transmitted by any means, electronically or mechanically, without the express, written permission of Pitney Bowes. We have made every reasonable effort to ensure the accuracy and usefulness of this manual; however, we cannot assume responsibility for errors or omissions or liability for the misuse or misapplication of our products.

Due to our continuing program of product improvement, equipment and material specifications as well as performance features are subject to change without notice. Your machine may not have some of the features described in this book.

E-Z Seal is a trademark or registered trademark of Pitney Bowes Inc.

ENERGY STAR is a registered trademark of the United States Environmental Protection Agency.

Safety	v
--------------	---

Chapter 1: Product Overview

Vertical Power Stacker	1-3
Capacity	1-3
Stacker-to-Insertor Communications	1-3
Stacker Access	1-3
Product Features	1-4
Getting the Most from Your Stacker.....	1-5

Chapter 2: Stacker Setup

Adjusting Stacker Wall.....	2-3
Unloading Material.....	2-3

Chapter 3: Clear Material

Clearing Material in the Stacker	3-3
Stacker Attached to Relay 2000/3000/4000	3-5
Stacker Attached to Relay 5000/6000/7000	3-7

Chapter 4: Troubleshooting and Error Messages

Troubleshooting	4-3
Stacker LEDs Indicators	4-3
Stacker Error Messages	4-4
Relay 2000/3000/4000 Insertor.....	4-4
Relay 5000/6000/7000/8000 Insertor.....	4-6
Stacker Operation in Non-Communicating Mode (Relay 2000/3000/4000 Only).....	4-7

Table of Contents

Chapter 5: Specifications

Specifications	5-3
Material Specifications	5-3
Size and Weight	5-3
Recommended Temperature and Humidity.....	5-3
Capacity	5-3
Stack Weight.....	5-3
Compatible Inserters	5-3
Envelope Size and Weight.....	5-4
Power.....	5-4
Communications Interface with Inserter.....	5-4
Stack Order	5-4

Safety

Follow these precautions when using your belt stacker:

- Use only Pitney Bowes approved supplies, in particular aerosol dusters. Improper storage and use of aerosol dusters or flammable aerosol dusters, can cause an explosive-like condition that could result in a personal injury and/or property damage. Never use aerosol dusters labelled flammable and always read instructions and safety precautions on the duster container.
- Read all instructions before operating the equipment. Only use the equipment for its intended purpose.
- Use the power cord supplied with the module. Plug it and all other supplied power cords into a properly grounded wall outlet located near the machine and easily accessible, meaning it is free from obstruction and there is enough room around the unit for servicing.
- Use only the AC adapter designed specifically for the stacker. Third-party AC adapters may damage the stacker.
- The power cord wall plug is the primary means of disconnecting the machine from the AC supply.
- Do not use an adapter plug on the line cord or wall outlet. Do not remove the ground pin from the line cord.
- Avoid using wall outlets controlled by wall switches or shared with other equipment. Do not route the AC adapter cable or power cord over sharp edges, or allow it to be trapped between furniture and/or furniture and the wall.
- Keep hands, loose clothing, jewelry, and long hair away from all moving parts.

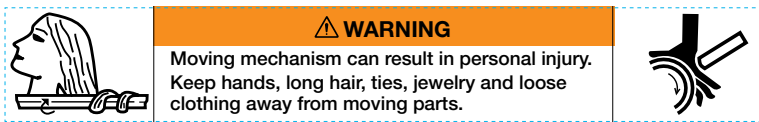

- Do not remove covers. Covers enclose hazardous parts that should only be accessed by properly trained service personnel.
- Immediately report to Pitney Bowes Service any damaged or non-functioning components. The unit may be unsafe for use.
- Operation of this equipment without periodic maintenance will inhibit optimum operating performance and could cause the equipment to malfunction. Contact Pitney Bowes for the required service schedule.

This page is intentionally blank.



1 • *Product Overview*

Contents

Vertical Power Stacker	1-3
Capacity	1-3
Stacker-to-Inserter Communications	1-3
Stacker Access	1-3
Product Features	1-4
Getting the Most from Your Stacker	1-5

This page is intentionally blank

Vertical Power Stacker

The Vertical Power Stacker is a compact, powered, bottom-feed stacker that connects to the output of several Pitney Bowes Document Inserting Systems, including the Relay 2000/3000/4000 and the Relay 5000/6000/7000/8000 Series. It neatly stacks the mail pieces fed from the inserter and keeps them in the same order as they were originally loaded.

Sensors in the stacker monitor the mail pieces fed into it; if a mail piece should stall or the stacker fills up, the inserter stops automatically. The stacker is designed for continuous unloading during mail runs to maintain best productivity. Unloading "on-the-fly" keeps your mail run going and helps avoid unnecessary interruptions.

Capacity

The stacker has a maximum capacity approximately equal to one standard USPS mail tray (21-inch / 530mm stack). Actual capacity will vary, depending on mail piece thickness and environmental conditions.

The stacker provides enough capacity so that by unloading on-the-fly, you are free to take care of other mail operations. The mail stack reaches maximum height only if you cease to unload on-the-fly. The stack height grows until it either trips the stacker-full sensor or trips another sensor that protects the motor from overloads due to a heavy stack.

Stacker-to-Inserter Communications

Communications between the inserter and stacker are handled by a serial (Relay 2000/3000/4000) or USB (Relay 5000/6000/7000/8000) interface cable. The stacker interface is "intelligent," which means the inserter will stop automatically when the stacker stops due either to an error or stacker-full condition.

Stacker Access

- For Relay 2000/3000/4000 inserters, a sliding tray assembly allows you to easily move the stacker away from the inserter to clear stalled mail pieces.
- For Relay 5000/6000/7000/8000 Series Inserters, a hinged mount allows you to open the stacker to clear stalled mail pieces.

1 • Product Overview

Product Features

Front View

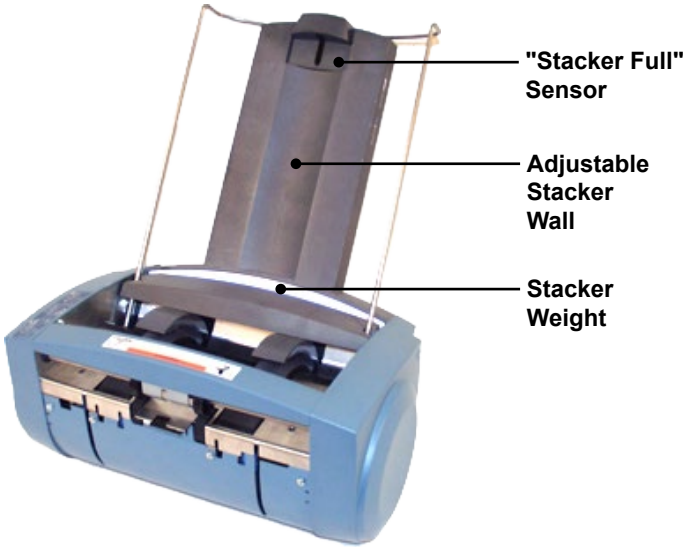

Side View



Rear View

Handle (to pull out stacker)

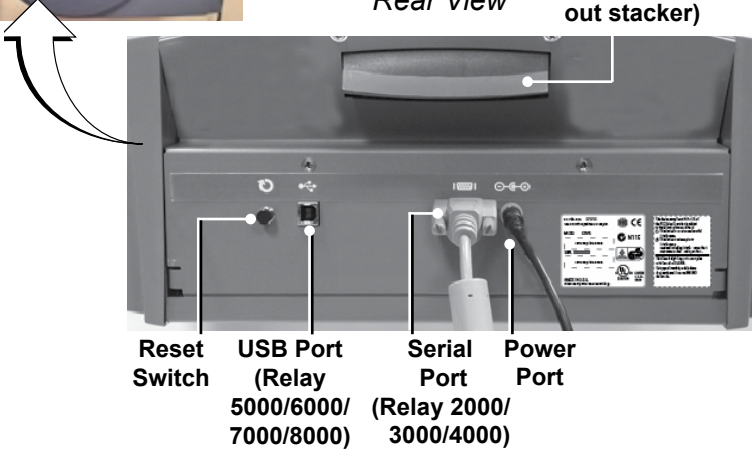

Getting the Most from Your Stacker

In most cases, the stacker will run and stack up to a maximum of 21 inches (530mm) - (the full length of a US Postal Mail Tray). However, this may prove impractical for certain applications and conditions.

We recommend adjusting the stacker to 3/4 height - approximately 16 inches (400mm) - to start off. This provides most applications with the best compromise between stack height and quality.

Some applications and operating conditions warrant a lower maximum stack height to ensure consistent stack quality in the event you let the system run to maximum stack height. Should this arise, lower the maximum stack height by 1 to 2 inches (25 to 50mm) until best stack quality is achieved.

Factors that affect maximum stack height include:

- Stack integrity (how neatly the envelopes align);
- Sealing quality (clean seals void of wrinkles or other imperfections);
- Outer envelope quality (no impressions or imperfections caused by stacker components, guides, or the stack itself);
- Humidity and temperature extremes; and
- Poor materials, such as some recycled envelopes and materials that have been improperly stored (not in a cool, dry place).

NOTES

- Standard practice is to unload on-the-fly, so that maximum stack height is reached infrequently, if ever at all.
- In some cases, before the stack reaches the top of the stacker wall, the stacker LED will blink red or green, indicating that it needs to be emptied. This is a normal condition and means the stack is too heavy.
- Excessive wetting may cause flap distortion. To alleviate this problem, use Pitney Bowes E-Z Seal® solution in the inserter's sealing reservoir. You may also set the stacker wall to a lower position and/or remove part of the stack while the job is running.

This page is intentionally blank

2 • *Stacker Setup*

Contents

Adjusting Stacker Wall.....	2-3
Unloading Material.....	2-3

This page is intentionally blank

Adjusting Stacker Wall

1. Grasp the stacker wall from top and slide it up or down to an appropriate position.
2. Use the knob on rear to tighten wall into place.

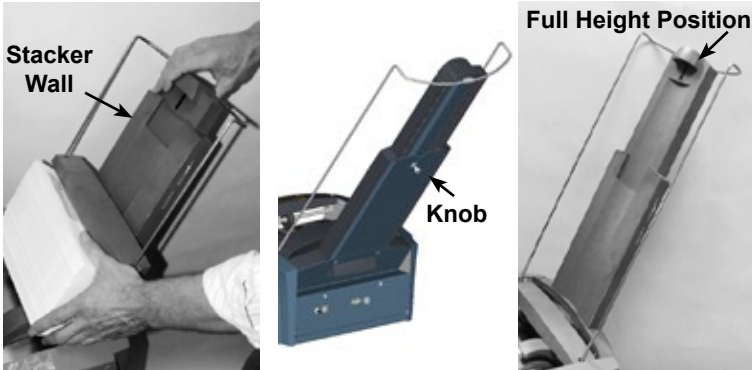

NOTE: Envelopes at the bottom of the stack could deform as stack weight increases. If this happens, set the stacker height wall to a lower position.

Unloading Material

1. Lift material from top of stack. (*Do not overfill hands to the point where they are in a strained or unnatural position.*)
2. Remove the material.

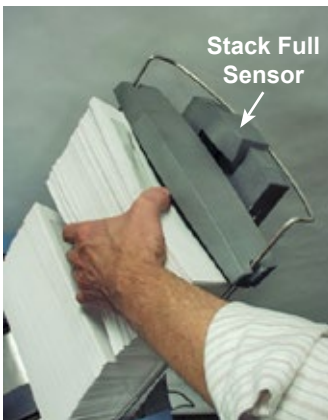

NOTE: Material can be removed while the stacker is running. The stacker will run as long as the stack-full sensor is not blocked for more than 1/2 second.

This page is intentionally blank

3 ● *Clear Material*

Contents

Clearing Material in the Stacker	3-3
Stacker Attached to Relay 2000/3000/4000	3-5
Stacker Attached to Relay 5000/6000/7000	3-7

This page is intentionally blank

Clearing Material in the Stacker

To clear material from the stacker:

1. Lift or remove material from stack and remove stalled piece.



**Stalled
Piece**

2. For Relay 2000/3000/4000 inserters, slide out the stacker from the inserter base and remove the stalled piece or pieces as shown in the figure, right. *(More detailed instructions included later in this guide.)*

OR



3. For Relay 5000/6000/7000/8000 inserters, unlatch the stacker, open it and remove the stalled piece or pieces. *(More detailed instructions included later in this guide.)*

NOTES:

- When the stacker stops, the operator display on the inserter displays a message telling you what happened and how to resume operation.
- You can also check the status of the stacker by looking at the status lamp (LED).

3 • Clear Material

- With some stacker errors you may need to press the stacker RESET switch to resume normal operation.

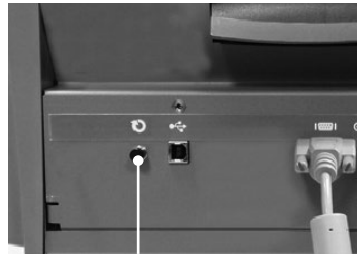

Reset Switch

Stacker Attached to Relay 2000/3000/4000

To clear material in a stacker attached to a Relay 2000/3000/4000:

1. Slide the stacker out and away from the inserter.

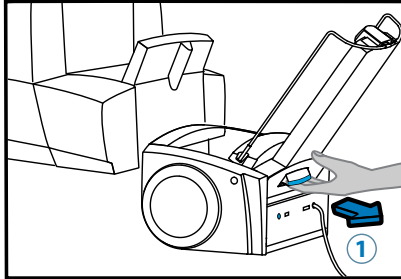

2. Lift the plastic cover (A) and lower the envelope exit area door (B) of the inserter and remove stalled material and close the latches.

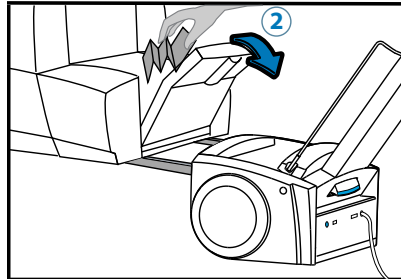
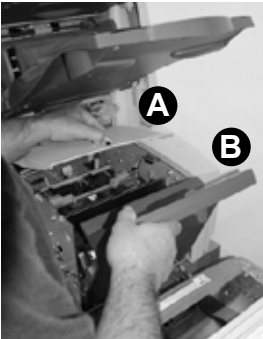

3. Slide the stacker back into the inserter. If the stacker is not pushed in all the way, the safety interlock will not engage and the system will not run.

3 • Clear Material

4. Press the RESET switch on the back corner of the stacker (4) or the Start key on the inserter.

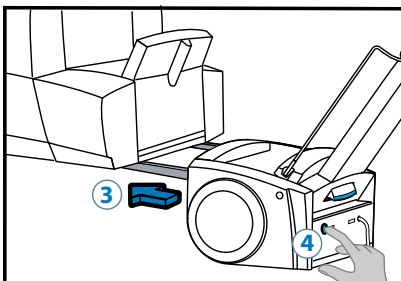

Stacker Attached to Relay 5000/6000/7000

To clear material in a stacker attached to a Relay 5000/6000/7000/8000:

1. Push stacker release lever UP.

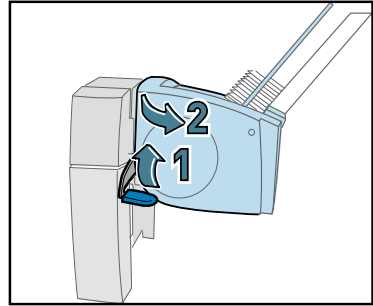

2. Open the stacker (shown here hinged on one side) and clear all the stalled material.

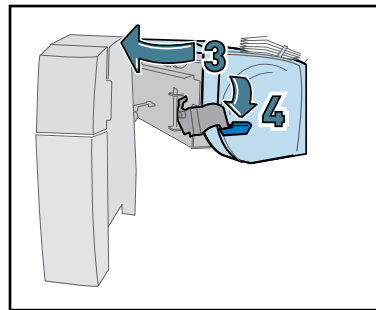

3. Close the stacker.



4. Push the stacker release lever DOWN to lock the it in place.



3 • Clear Material

5. Resume operation as follows:
 - a. Double check all stalled material is cleared.
 - b. Press the **START** button on the inserter control panel.

NOTE: Some stacker faults may require you to press the stacker's RESET switch to resume normal operation. See the error messages in this guide.

4 • *Troubleshooting and Error Messages*

Contents

Troubleshooting	4-3
Stacker LEDs Indicators	4-3
Stacker Error Messages	4-4
Relay 2000/3000/4000 Inserter.....	4-4
Relay 5000/6000/7000/8000 Inserter.....	4-6
Stacker Operation in Non-Communicating Mode (Relay 2000/3000/4000 Only).....	4-7

This page is intentionally blank

Troubleshooting

Stacker LEDs Indicators

		
LED	Relay 2000/3000/4000	Relay 5000/6000/7000/8000
No Light	No power to stacker	No power to stacker
Green On	Normal operation	No error; normal operation
Green Blinking	Stacker almost full; remove stack.	N/A
Amber	N/A	Stacker almost full; remove stack
Red Blinking	Stacker full; remove stack	N/A
Red On	Press reset switch to clear error condition	Error; correct error condition
Red - 2 Blinks	Transport jam; remove stalled piece and press reset switch or Start key on inserter	N/A
Red- 3 Blinks	Cover open or stacker pulled away from the inserter - close cover or slide stacker into place. and press reset switch or inserter Start key.	N/A
Red - 4 Blinks	Stacker error - remove stalled piece if present and press reset switch or inserter Start key.	N/A
Red - 5 Blinks		

4 • Troubleshooting and Error Messages

Stacker Error Messages

Relay 2000/3000/4000 Inserter

Error Message	Solution	Additional Comments
Stacker Not Detected; Press START to Retry or STOP to Uninstall.	Check the serial cable that connects the power stacker and inserter for correct installation. If this problem persists, call for service.	You can also press STOP to un-install the stacker. This disables stacker communications and allows you to run the stacker in non-communicating mode until service can resolve issue/
E118 — Check Stacker Position	Power stacker was pulled out during a trial piece run or mail job run. The safety interlock switch is open. Push the stacker back into its normal operating position.	Stacker slides on rails. If for some reason the rails are bent and the stacker can't be moved back to its proper position, this error could persist. Call for service.
E123 — Check Stacker Position	Power stacker was pulled out during a trial piece run or mail job run. The safety interlock switch is open. Push the stacker back into its normal operating position.	Power stacker was pulled out during a trial piece run or mail job run. The safety interlock switch is open. Push the stacker back into its normal operating position.
E116 — Stacker Error	Power stacker stopped. An error (cam failed to go to home position) occurred while performing an operation.	Check for and clear any stalled material. Press the Reset button on the stacker. Press inserter START button to resume operation. If this condition persists, call for service.
E114 — Stacker Full Press STOP	Empty the stacker. Press START to resume operation or STOP to return to the home ready screen.	This message occurs only if you choose to continue running the machine without emptying the stacker after the "Empty Stacker..." message displays. This is not recommended.

Troubleshooting and Error Messages • 4

Error Message	Solution	Additional Comments
E117 — Clear Stacker Entry Area	<p>A mail piece has stalled at the stacker entry.</p> <p>Pull the stacker away from the inserter and clear the stalled material.</p> <p>Push the stacker back into position and inspect the inserter transport .</p> <p>Press STOP to clear the error and return ton the home ready screen or press CLEAR DECK to clear the error and start the clear deck process.</p>	<p>Be sure to push the stacker all the way in to engage the safety interlock. Otherwise you'll see a stacker position error (E123).</p>
Empty Stacker then Press START	<p>The power stacker is almost full. Empty the stacker and press START to resume operation.</p> <p>If you press START without emptying the stacker, the inserter continues to run until the stacker is full.</p> <p>You can also press STOP to return to the home ready screen.</p>	<p>When this message displays, the inserter completes processing of all staged mail pieces and then stops automatically.</p> <p>We recommend you empty the stacker frequently; do not let it get too full.</p>

4 • Troubleshooting and Error Messages

Relay 5000/6000/7000/8000 Inserter

Error Message	Solution Displayed	Additional Comments
230 — VPS Entry Nip Jam	Stacker stopped. Remove material from stacker.	Check for and clear obstructions in the stacker, especially in the entry area. It may be necessary to open the stacker to completely clear the stall. Press inserter START button to resume operation.
231 — VPS Cam Error	Stacker stopped. An error occurred while performing an operation.	Check for and clear any stalled material. Press Reset button on stacker. Press inserter START button to resume operation. If this condition persists, call for service.
232 — VPS Cam Overcurrent	Stacker stopped. An error occurred while performing an operation.	The stacker stopped to protect against a motor overload. This is often due to a stack that's too heavy. Try removing finished mail pieces more frequently or lower stack wall height. Press Reset button on stacker and press START to resume operation.
233 — VPS Stack Overfull	Stacker full. Clear stacker.	Empty the stacker. See <i>Getting the Most from Your Stacker</i> for details on adjusting stack height for your material.
234 — Stack Current Limit		See error 232.
389 — Almost Full Warning	Stacker almost full. Clear stacker.	Empty the stacker to avoid a stacker-full condition and system stop.
433 — VPS Cover Open	VPS cover open; close cover.	The stacker is not completely closed. Close the stacker all the way and push DOWN on the release lever to lock it in position.

Stacker Operation in Non-Communicating Mode (Relay 2000/3000/4000 Only)

The stacker is designed to communicate with your Pitney Bowes inserter by means of a serial connection.

This is called an "intelligent" interface; it allows sensors in the stacker to monitor mail piece flow so that when the stacker fills up or a mail piece stalls, the inserter stops automatically.

If the "Stacker not Detected" or "E108-Power Stacker Not Detected" error displays on Relay™ 2000/3000/4000 inserters, check the serial cable that connects the inserter and stacker. Try resetting the stacker (see page 3 for location of RESET switch), then press START. If this fails to correct the problem, you may run the stacker in non-communicating mode.

Select "Uninstall Stacker" (an option on the inserter display that appears with the error message). The error message will not occur again. The stacker is now in non-communicating mode; you can run it this way as a temporary measure until Pitney Bowes service can resolve the problem.

IMPORTANT: Please note the following when you run the stacker in non-communicating mode:

- No error messages will be sent to the inserter regarding the stacker. If a stalled mail piece or stack-full condition occurs, the inserter will continue to feed mail into the stacker and create more stalled mail pieces, eventually stopping the inserter.
- You must empty the stacker more frequently before it reaches maximum stack height and overflows.
- When an obstruction or stall does occur, do the following:
 1. Press **Stop** on the inserter.
 2. Clear any obstructions from the inserter and/or the stacker.
 3. Press the **Reset** button on the stacker.
 4. Press **Clear Deck** on the inserter control panel to ensure materials are cleared.
 5. Press **Start** or follow any additional instructions on the inserter control panel display.

This page is intentionally blank

5 • *Specifications*

Contents

Specifications	5-3
Material Specifications	5-3
Size and Weight	5-3
Recommended Temperature and Humidity...	5-3
Capacity	5-3
Stack Weight	5-3
Compatible Inserters	5-3
Envelope Size and Weight	5-4
Power	5-4
Communications Interface with Inserter	5-4
Stack Order	5-4

Specifications

Material Specifications

Size and Weight

- Weight - 21 lbs. (9.5kg)
- Size - 17 inches (432mm) wide x 24 inches (610mm) high

Recommended Temperature and Humidity

	Minimum	Maximum
Temperature	60°F (16°C)	75°F (24°C)
Humidity	30%	60%

Capacity

- 21-inch (530mm) stack height, maximum, when fully extended

NOTE: This is equivalent to the capacity of one standard USPS mail tray or approximately 300 envelopes with two tri-fold inserts each. Actual capacity will vary, depending on mail piece thickness and environmental conditions.

Stack Weight

- Stack weight is 20 pounds (9 kg), maximum

NOTE: It is possible that envelopes at the bottom of the stack could deform as stack weight increases. If this is a problem, set the height of the stacker wall at half-height rather than its fully extended position.

Compatible Inserters

The Vertical Power Stacker is designed to operate with the following Pitney Bowes inserting systems:

- Relay 2000/3000/4000
- Relay 5000/6000/7000/8000

IMPORTANT: Model and feature availability varies by country. Contact your machine supplier for more information. This guide covers all models and features. Information included in this guide does not guarantee availability of a particular model or feature within your country.

5 • Specifications

Envelope Size and Weight

NOTE: We recommend you use quality materials. Using recycled envelopes may prevent the stack from reaching full height due to deformation of the bottom envelopes caused by too much stack weight.

	Minimum	Maximum
Width	6.3 inches (162mm)	10.5 inches (266mm)
Depth	3.5 inches (89mm)	6.5 inches (165mm)
Weight	20 lb. (80gsm)	24 lb. (80gsm)

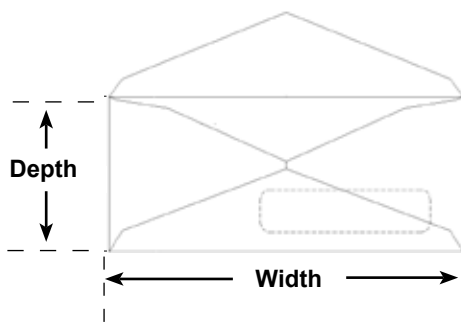

Power

- External power supply:
 - 00-240 VAC
 - 50/60 Hz input
 - 24 VDC
 - 3A output

Communications Interface with Inserter

- * Serial for Relay 2000/3000/4000 inserters
- * USB for Relay 5000/6000/7000/8000 inserters

NOTE: If you disconnect the communications cable going to the inserter, the stacker can run by itself (Relay 2000/3000/4000 only) but no messages will be sent back to the inserter.

Stack Order

- Stacks in same order as the mail pieces were loaded into the inserter.

This page is intentionally blank.

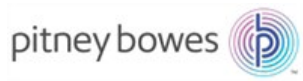

3001 Summer Street
Stamford, CT 06926-0700
www.pitneybowes.com

SV61322 Rev. D
©2015 Pitney Bowes Inc.
All Rights Reserved