

Quick Guide

Please start by reading this guide.
It describes basic operations.

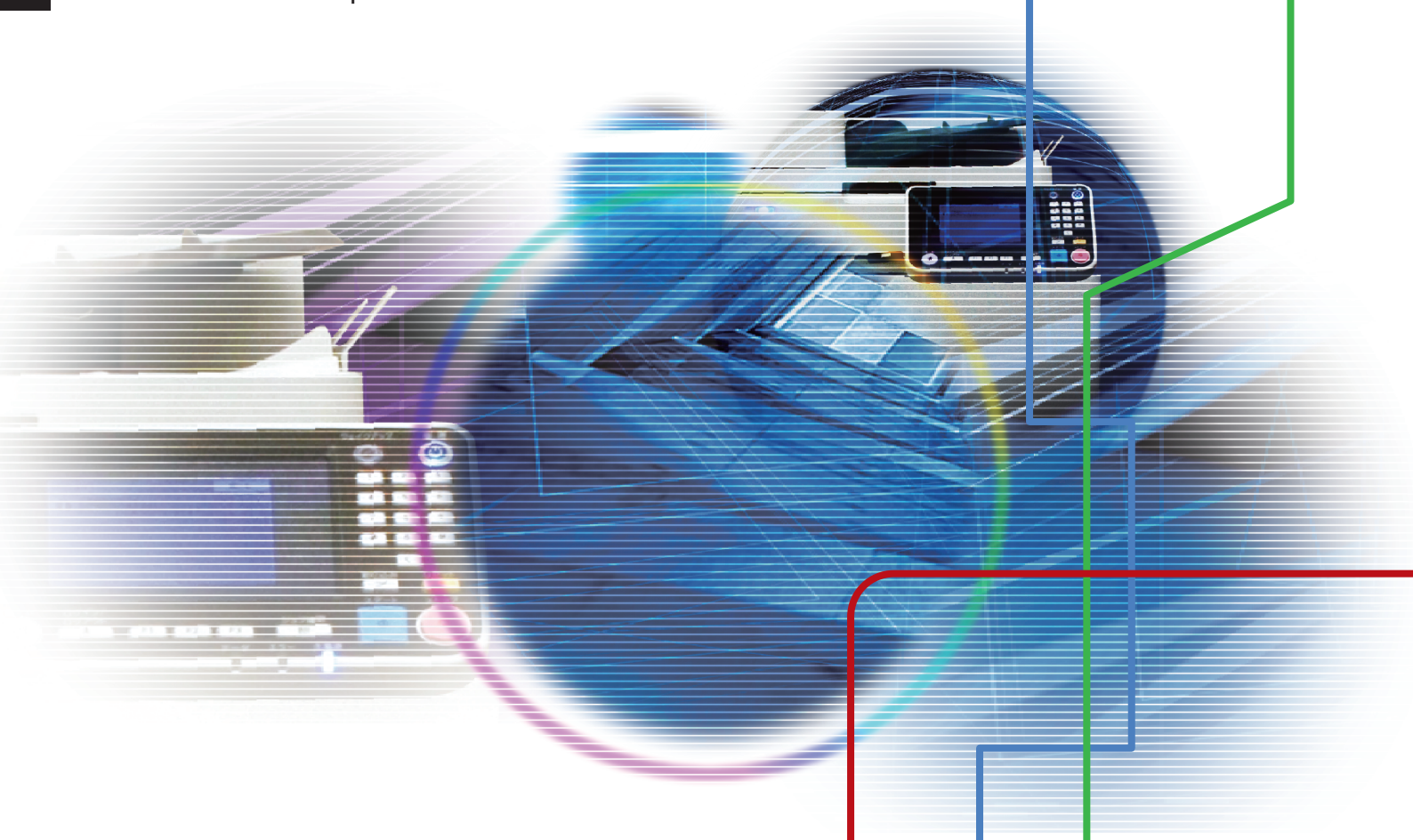

ComColor GD Series
9630/9630R/9631/9631R/7330/7330R

This device is compliant with the substance emission inspections of the German environmental label "RAL-UZ171".



CAUTION

After reading this guide, keep it handy for future reference. The "Safety Precautions" are provided in the supplemental Safety Information. Be sure to read through them prior to use.

Preface

Thank you for using a ComColor GD Series product.

This ComColor GD Series product is a network-compatible inkjet printer that performs high-speed color printing.

About the Guides

The five guides described below are supplied with this machine.

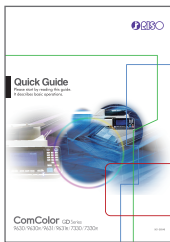

Quick Guide (this guide)

This guide describes basic machine operations and how to replace consumables. Keep this guide handy, such as near the machine, for easy reference. Start by reading this guide. For a detailed explanation of each function, see the "User's Guide".

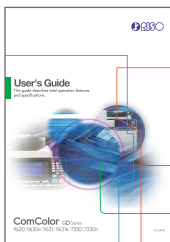

User's Guide

This guide describes handling precautions and specifications, as well as the operations and settings of each function. Read this guide for a more detailed understanding of the machine.

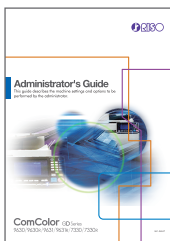

Administrator's Guide

This guide describes the machine settings and optional equipment to be configured by the administrator.

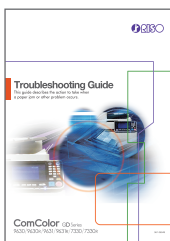

Troubleshooting Guide

This guide describes the actions to take when a paper jam or other problem occurs.



Safety Information

This guide describes safety precautions and specifications.

About This Guide

Symbols Used in This Guide



Indicates cautions that should be noted for safe use of this machine.



Indicates important items that should be noted or are prohibited.



Indicates useful or additional information.

Names of Keys and Buttons

The names of hard keys on the operation panel and buttons/items on the touch panel screen or computer window are indicated with square brackets [].

● Operation panel

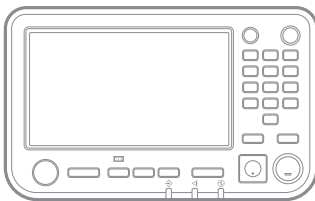

Example: Press the [Stop] key.

● Touch panel screen

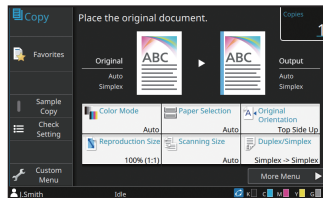

Example: Touch [Color Mode].

● Computer window

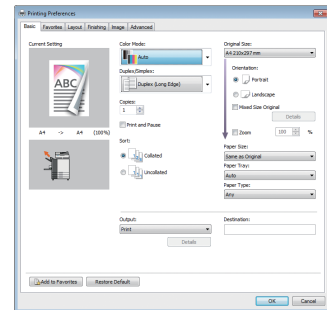

Example: Select the [Mixed Size Original] check box.

Illustrations and Operating Procedures in This Guide

- The operating procedures, screenshots, and illustrations in this guide are for the ComColor GD9630/GD9630R with the optional scanner connected. This guide also assumes that each function is set to the factory setting, and that [Login Setting] is set to [ON].
- The screenshots and illustrations in this guide may vary depending on the machine model and usage environment, including the connected optional equipment.

Operating This Machine



This machine is operated using the buttons on the touch panel and the keys on the operator panel.

About This Machine ↩ p.4

Operating the Touch Panel ↩ p.7

- (1) This guide may not be reproduced in whole or in part without the permission of RISO KAGAKU CORPORATION.
- (2) The contents of this manual may be changed without prior notice due to product improvements.
- (3) RISO KAGAKU CORPORATION shall not be liable for any consequence of using this guide or the machine.

Contents

Preparation	
About This Machine.....	4
Turning On the Power	6
Operating the Touch Panel.....	7
Logging In.....	8
Loading Originals	9
Getting Started	
Copying	10
 Loading Orientation of Originals and Paper	11
About the Various Copying Functions	12
Scanning	14
 What is the [Favorites] Function?	15
Printing	16
About the Various Printing Functions	18
Using Storage.....	20
Using a USB Flash Drive.....	22
Routine Care	
When Paper Runs Out	24
When Ink Runs Out.....	26
Scanner Care	28
 Useful Tips	29
Consumables	29
RISO Console	29
Cleaning the Print Head	29
Storing Consumables	30
Originals That May Not Be Copied	30

About This Machine

Main Unit and Optional Scanner

This section describes the main parts of the machine.

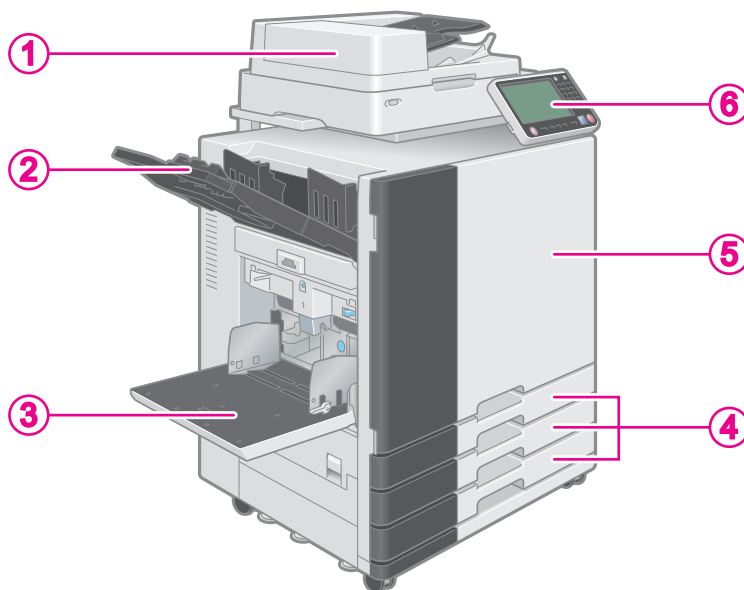

① Scanner

Use the scanner to copy or scan documents that are read from the platen glass or the ADF (automatic document feeder).

Copying ↪ p.10

Scanning ↪ p.14

② Face down tray

Printouts are output face down.

③ Standard tray

Load special paper (thick paper, envelopes, etc.) here. You can also load plain paper.

When Paper Runs Out ↪ p.24

④ Feed trays

Load the paper to be used for printing here. Special paper such as thick paper cannot be loaded.

When Paper Runs Out ↪ p.24

⑤ Front cover

Open when paper is jammed or when replacing an ink cartridge.

When Ink Runs Out ↪ p.26

⑥ Operation panel

Use to perform operations or configure settings. The viewing angle can be adjusted for improved visibility. The USB port is located on the left side.

Operation Panel ↪ p.5

Using a USB Flash Drive ↪ p.22

Operation Panel

This section describes the main parts used with the operation panel.

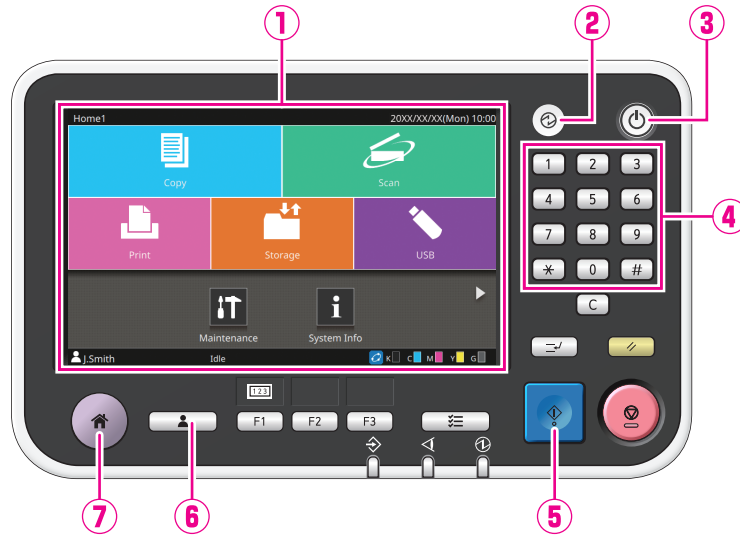

① Touch panel

Use to perform operations or configure settings.

② Wake Up key

This key lights up when this machine is in power saving mode.
Pressing this key when it is lit makes the machine ready for operation.
Pressing this key when it is not lit puts the machine into sleep state.

③ Power key

When pressed, the power turns on and the key lights up.
To turn off the power, press and hold the key.

④ Numeric keys

Use these keys to enter numbers.

⑤ Start key

Press this key to start an operation.

⑥ Login / Logout key

Press this key to log in or log out.

⑦ Home key

Press this key to return to the [Home1] screen (initial screen) from the screen for each function.

Preparation

Turning On the Power

1 Press the [Power] key on the operation panel.

-  The machine automatically enters power saving mode if you leave it unattended for some time. Press the [Wake Up] key to operate the machine.

The [Home1] screen is displayed after the startup screen.

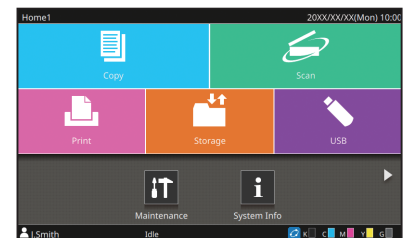
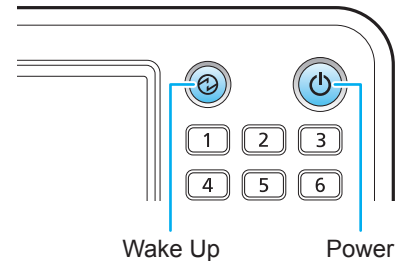

[Home1] screen



Reducing power consumption

You can reduce the machine's level of power consumption by setting the power saving mode. For the power saving mode, you can select the backlight OFF state and one of two types of sleep states with different levels of power consumption ([Low] or [Standard]). The amount of time that elapses before the machine enters each state, as well as the power consumption value, are set by the administrator. It takes longer for the machine to resume operations after sleep state than backlight OFF state, but power consumption is lower.

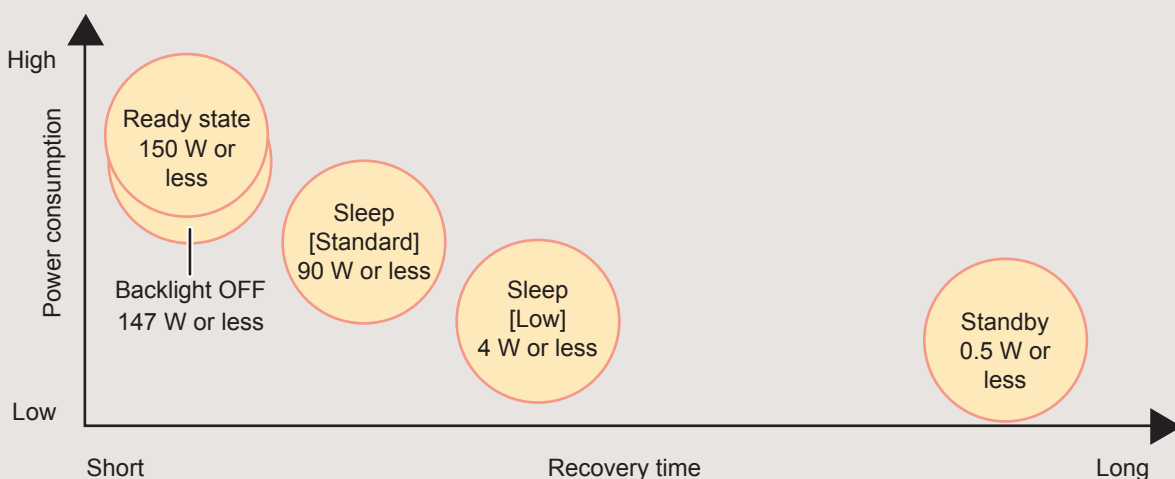

Preparation

Operating the Touch Panel

Touch

Touching a button will select the item.

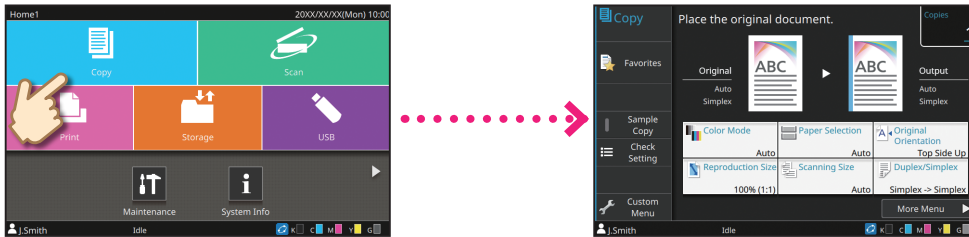

Flick

Flick your finger in any directions on the touch panel.
On the [Home1] screen, flick to switch to the [Home2] screen.

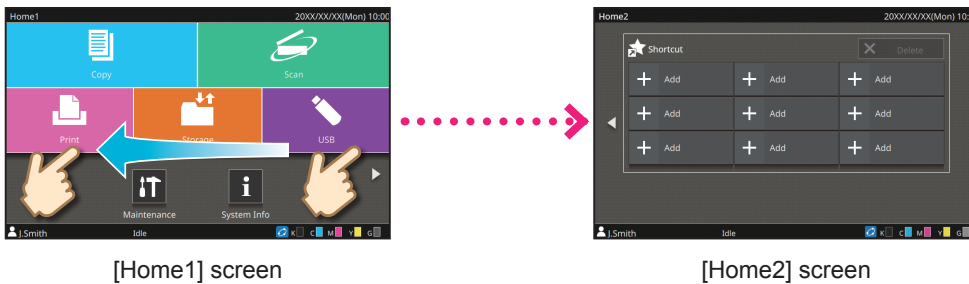

[Home1] screen

[Home2] screen

On other screens, flick to scroll the setting items or lists.

Drag

Slide your finger in any directions without lifting from the touch panel.
Drag to scroll through setting items and lists. The scrolling will stop when you remove your finger from the touch panel.

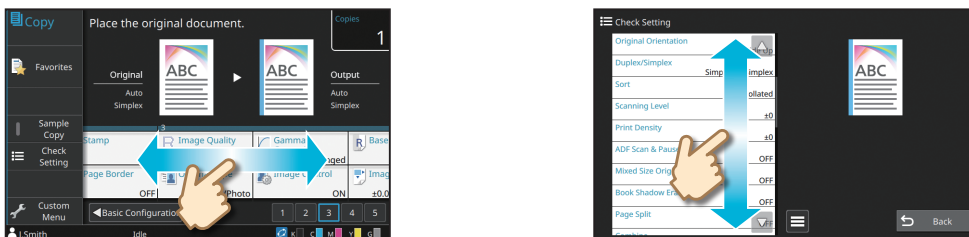

Preparation

Logging In

1 Press the [Login/Logout] key.

The [Login] screen is displayed.



The [Login] screen can be displayed regardless of the mode button that is touched.

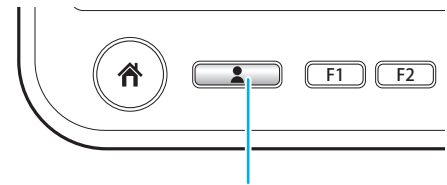

Login / Logout

2 Select the user name.

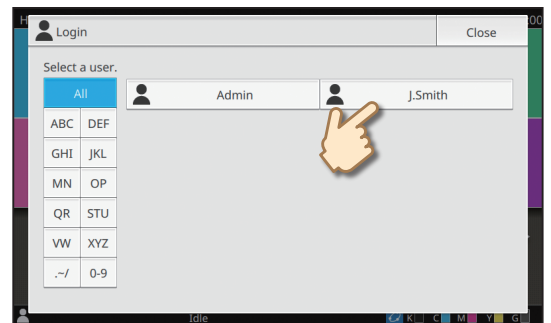

3 Enter your password and touch [Login].

To log out, press the [Login/Logout] key.

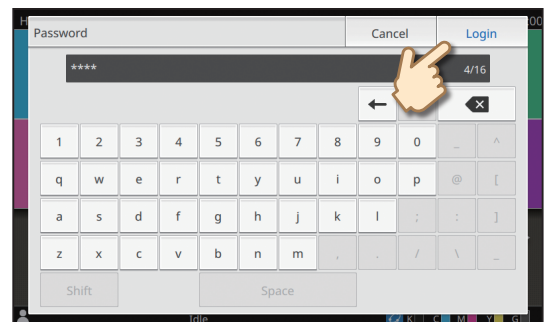

When Logging In for the First Time

Change the temporary password provided by the administrator to a password of your own choosing.

1. Enter the temporary password on the [Password] screen, and touch [Login].
The [Change Password] screen is displayed.
2. Enter the new password and touch [Next].
3. Enter the new password again and touch [OK].

Preparation

Loading Originals

Loading in the ADF

If you used ink or correction fluid on the original, make sure that it has fully dried before loading it.

1 Load the original so that the side that you want to scan is facing up.

Slide the ADF original guides to match the width of the original.

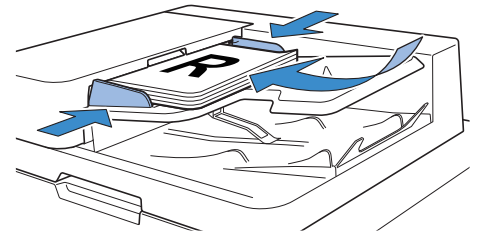

Loading on the Platen Glass

If you used ink or correction fluid on the original, make sure that it has fully dried before loading it.

1 Place the original so that the side that you want to scan is facing down.

Align the corner of the original with the arrow at the top left corner of the glass.



- When placing a transparency, set white paper behind it so that the original can be clearly read.
- If the original is extremely thin, the rear surface may be visible in the image. You can prevent this by placing black paper behind the original.

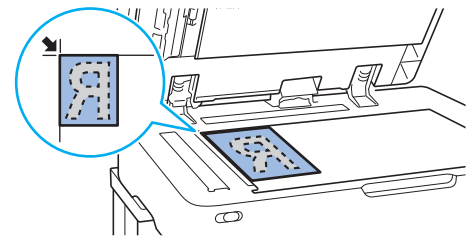

2 Close the original cover.



Types of Originals That Cannot Be Loaded in the ADF

The originals listed below cannot be scanned using the ADF. Set them on the platen glass.

- Originals that have been cut and pasted
- Originals with significant wrinkling or curling
- Bent originals
- Glued originals
- Originals with holes
- Torn originals or originals with jagged edges
- Highly transparent originals such as transparencies or tracing paper
- Originals with a coating on the front or rear, such as art paper or coated paper
- Thermal paper used in facsimiles or word processors
- Originals with significant bumps on the surface

Getting Started

Copying

1 Load the original.

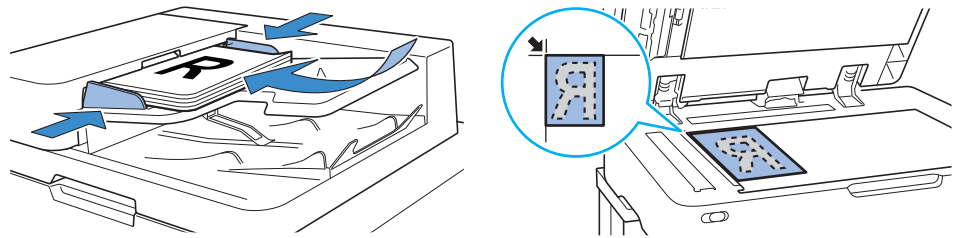

2 Touch [Copy] on the [Home1] screen.

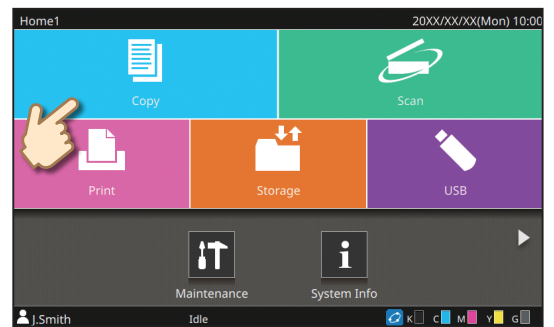

3 Change the settings as needed.

Enter the number of copies using the numeric keys.

About the Various Copying Functions p.12

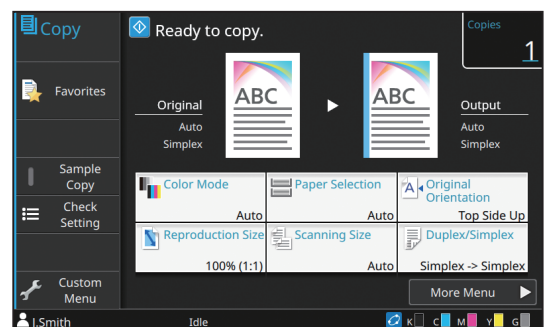

4 Press the [Start] key.

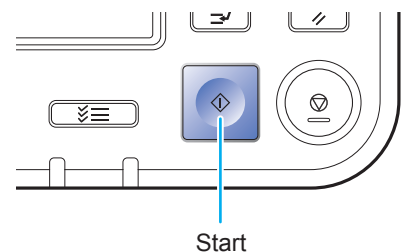



Loading Orientation of Originals and Paper

When you are copying on letterhead paper, envelopes, or other paper with a pre-printed logo, the orientation of the original and paper is important.

The orientation of the original and paper is described below, using an example of copying a single-sided original.

Example of Loading Envelopes

On the touch panel, set [Original Orientation] to [Top Side Left].

Original orientation
Load originals so that the bottom edge is scanned first.

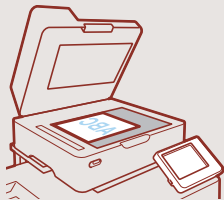

Envelope loading orientation
Load envelopes so that the bottom edge enters the machine first.

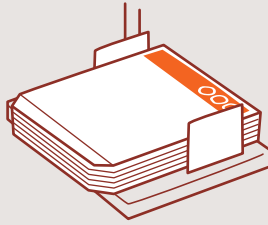

Output orientation



Example of Loading Letterhead Paper

On the touch panel, set [Original Orientation] to [Top Side Up].

Original orientation

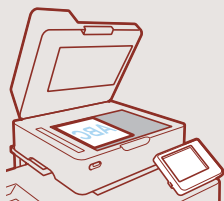

Paper loading orientation

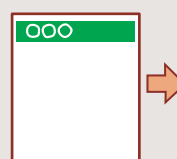
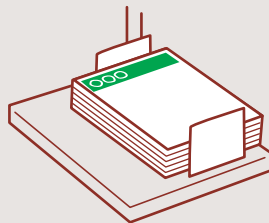

Output orientation (when output face up)

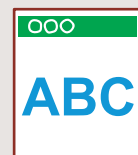

About the Various Copying Functions

Sample Copy

Output one sample before making a large number of copies. This enables you to check the results and settings.



Sort

When making multiple copies of multi-page originals, you can specify whether to print by the page or by the set.

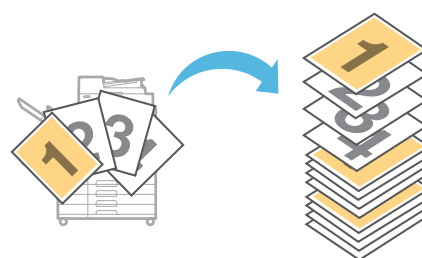

Mixed Size Original

Scan originals that consist of pages that vary in size.

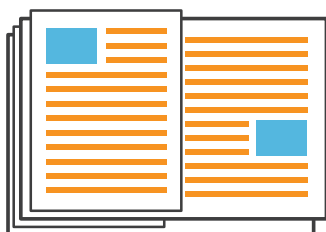

Page Split

When copying double-spread pages of documents such as booklets, split the pages into two parts (left and right) and copy them separately.



Stamp

Stamps the page number, date, or text on the header or footer.

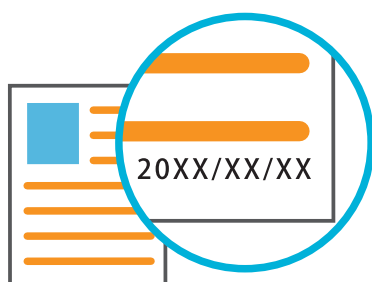

Page Border

Add a border line in the margins of the paper. This enables you to make posters and signs stand out.

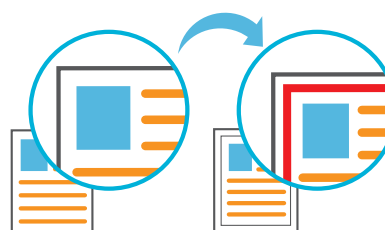

Original Type

Copy a document with image processing to suit the type of original such as photos and pencil drawings.

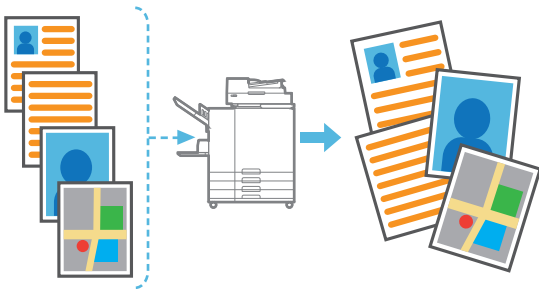

Gamma Correction

Correct the balance of colors the original contains to create more natural colors.

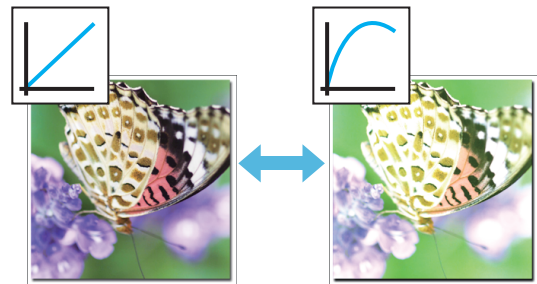

Base Color Level

Make the background color (base color) lighter when scanning an original with a background color.

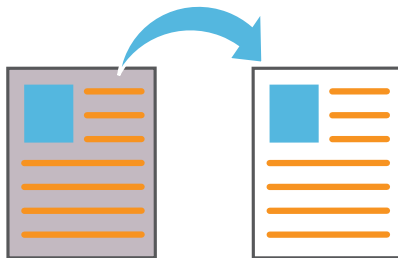

Add Cover

Attach a front or back cover to the document that has been copied.

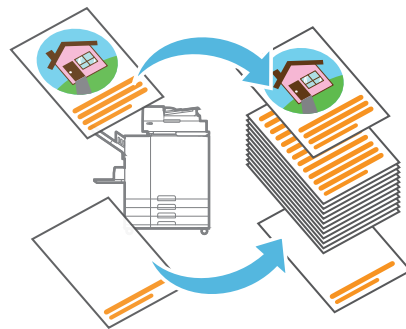

Slip Sheet

Insert a slip sheet between sets of copies. This enables you to quickly separate a large amount of meeting documents or handouts.

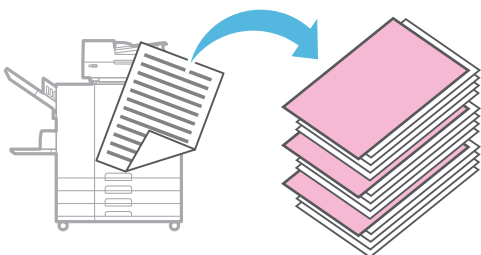

Auto Image Rotation

Automatically rotate the image by 90 degrees so that the original data matches the orientation of the paper.

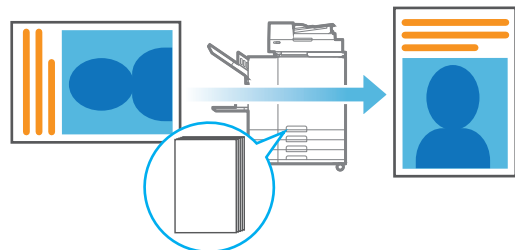

Getting Started

Scanning

You can select either [Mail], [PC], or [Console] as the destination for sending or storing the data. In this section, the procedure for sending the data to a computer is described as an example.

1 Load the original.

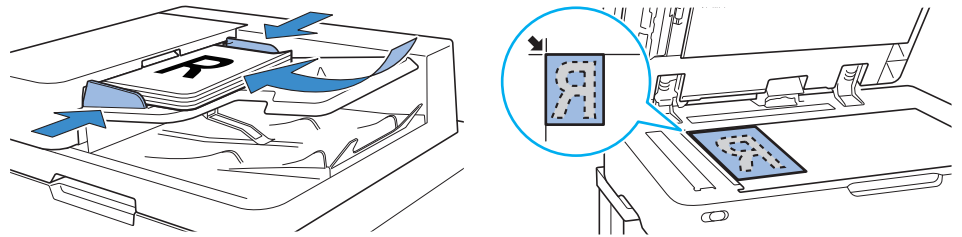

2 Touch [Scan] - [PC] on the [Home1] screen.

Select [Mail] to send the scanned data by e-mail, or select [Console] to save the scanned data to the internal hard disk of this machine.

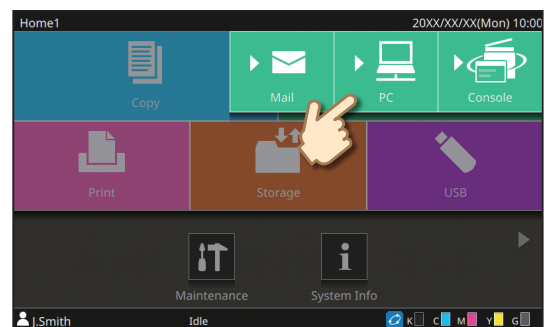

3 Touch [Destination], and select the destination.

Change the settings as needed.

For [Mail], touch [Address] to configure the address. For [Console], it is not necessary to configure the destination.

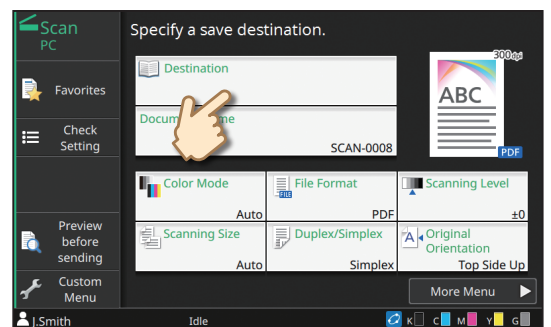

4 Press the [Start] key.

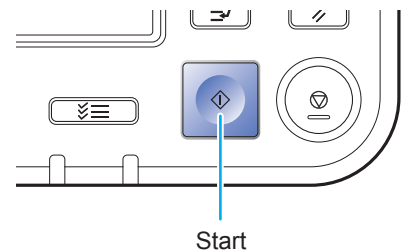



What is the [Favorites] Function?

The details configured in the [Copy] screen and the [Scan] screen can be registered as [Favorites]. If you register the settings you frequently use, you can eliminate the need to configure the same settings each time. Add shortcuts of registered [Favorites] to the [Home2] screen to bring these up at any time.

Registering the current settings for future use

1 Touch [Custom Menu].

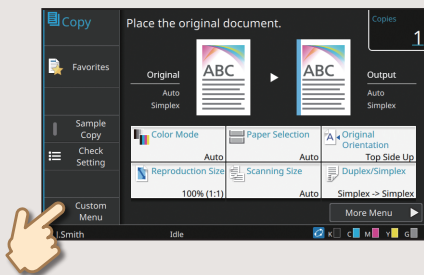

2 Touch [Create].

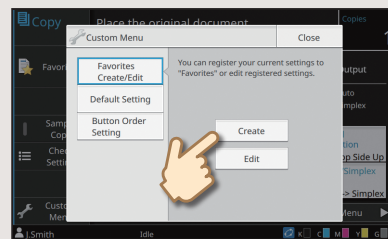

Perform registration by following the instructions provided on the screen.

Creating a shortcut of [Favorites]

Shortcuts of [Favorites] can be created on the [Home2] screen.

1 Touch [Add] on the [Home2] screen.

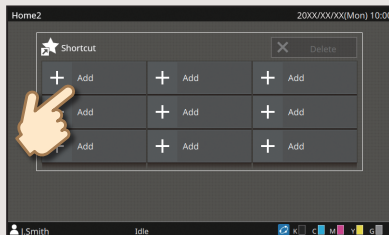

2 Pick a favorite from the list and touch [OK].

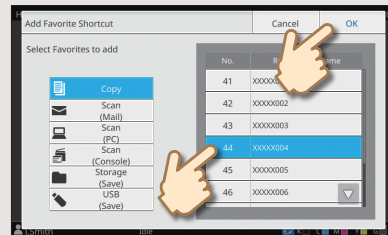

Once a shortcut has been created

Touch the registered shortcut to bring up the settings registered with the favorites.

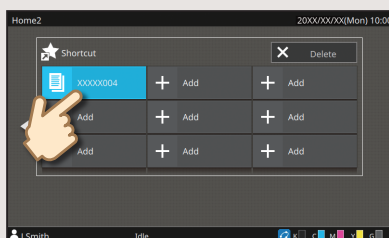

Press the [Start] key to start copying or scanning with the settings that have been loaded.

Sending Data to This Machine

In this section, the procedure for printing from the Microsoft® Windows® 7 Notepad application is described as an example.

1 Click [Print...] in the [File] menu.

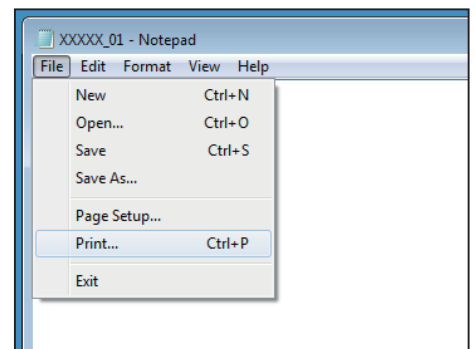

2 Click [Preferences], and check the settings.

After confirming the settings, click [OK] and close the printer driver screen.

About the Various Printing Functions p.18

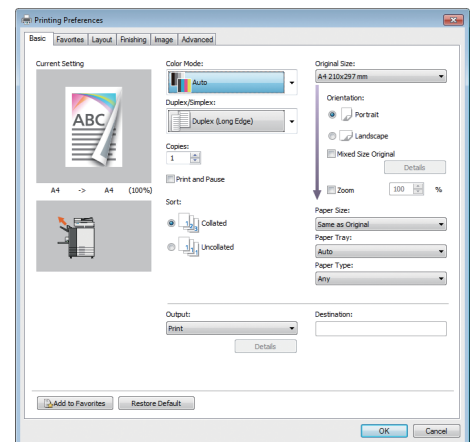

3 Click [Print].

The print data is sent to this machine.

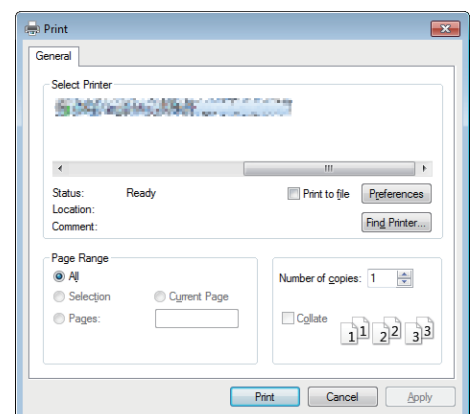

Printing from This Machine

At the factory settings, the machine starts printing automatically when you log in. If printing does not start automatically when you log in, perform the procedure below.

1 Touch [Print] on the [Home1] screen.

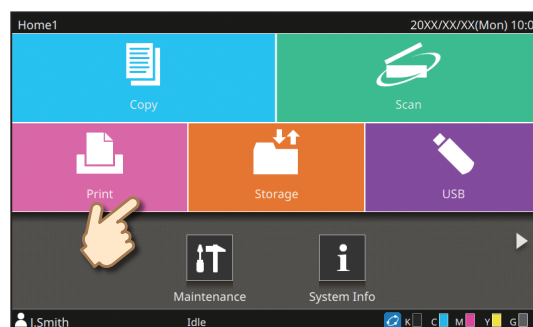

2 Select the job.

You can touch [Thumbnail] to view the waiting jobs as thumbnails.

You can touch [Select All] to select all jobs.

 To deselect all jobs, touch [Select All] again. To deselect each job, touch the job individually.

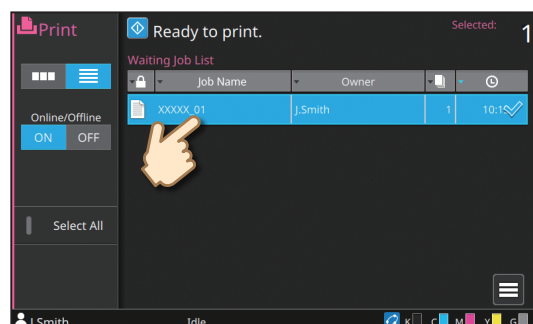

3 Press the [Start] key.

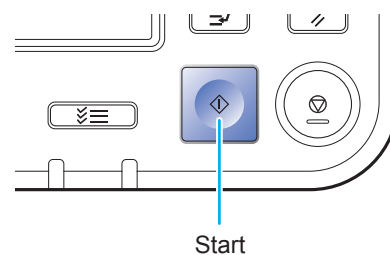

About the Various Printing Functions

Print and Pause

Print one sample before printing a large number of pages. This enables you to check the results and settings.



Paper Type

Print using the optimal colors for the type of paper.

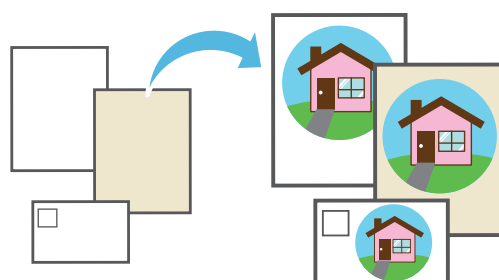

Storage

Save the documents you frequently print in a folder of the machine.



Combine

Print continuous pages together on one sheet. You can use this setting to save paper.



Booklet

Reorder the pages to be in the correct order when folded in half.



Binding Edge

Configure the position at which the paper will be bound. The binding margin can also be adjusted.

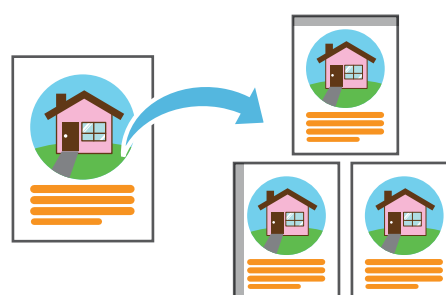

Data Compression

Reduce the data file size and prioritize network communication speed over image quality when you print.

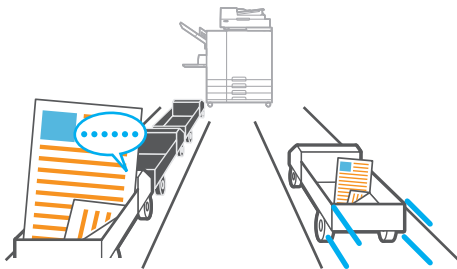

Screening

Configure whether to express continuous gradations with the density of dots or with the size of dots.

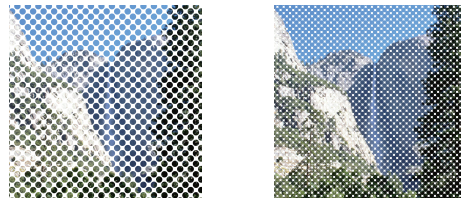

Envelope Imaging

Minimize blurring and smudging when printing on envelopes.

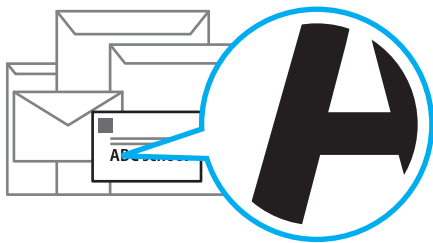

PIN Code

A PIN code can be configured for documents that are confidential.



Program

Print according to a preconfigured program for the number of copies or number of sets. The slip sheet function can also be configured.

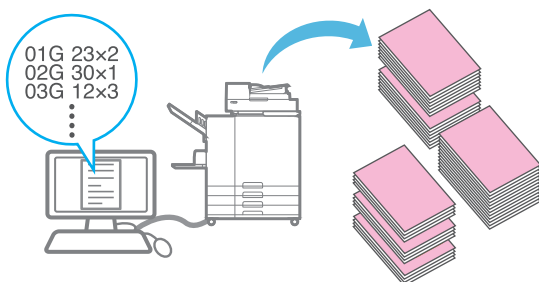

Blank Page Detection

Specify this to prevent blank pages of the original from being printed.

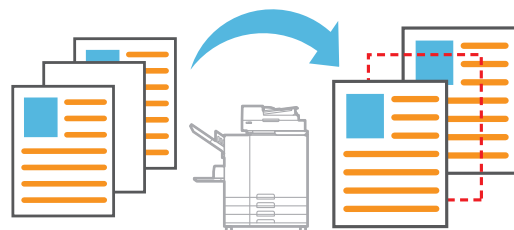

Saving Scanned Data to Storage

The scanned data is saved along with the print settings.

1 Load the original.

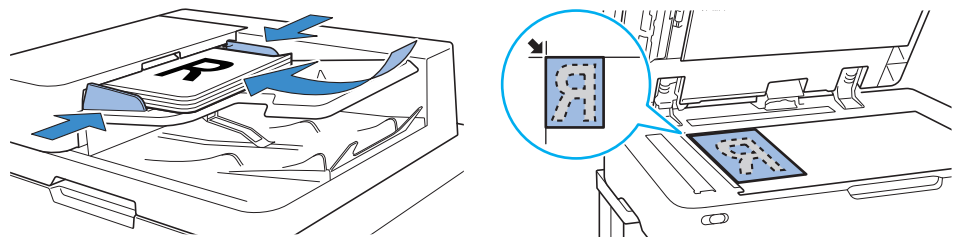

2 Touch [Storage] - [Save] on the [Home1] screen.

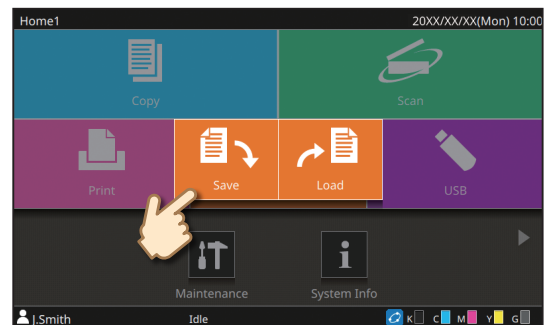

3 Select the destination folder and touch [Save Document].

You can change the settings.

You can touch [Add Folder] to create a new folder to use as the destination.

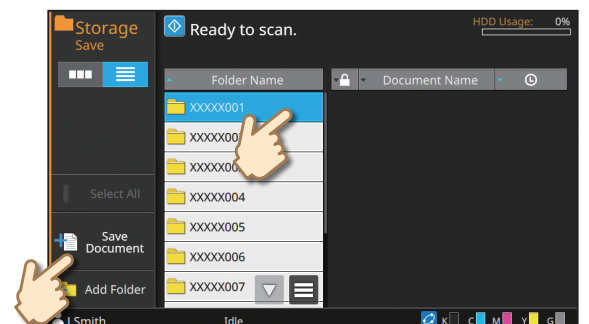

4 Press the [Start] key.

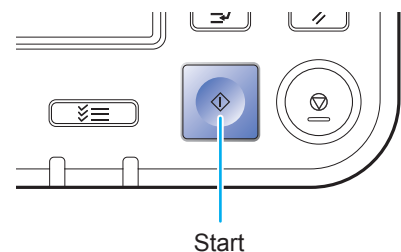

Printing Saved Data from Storage

The data is printed with the settings saved along with the data.

1 Touch [Storage] - [Load] on the [Home1] screen.

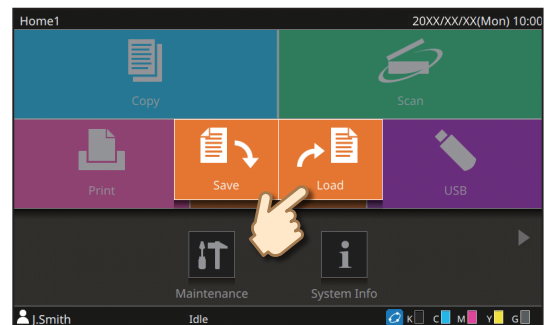

2 Select the folder that you want to load, and select the document.

You can touch [Search] to search for documents.
Enter the number of copies using the numeric keys.

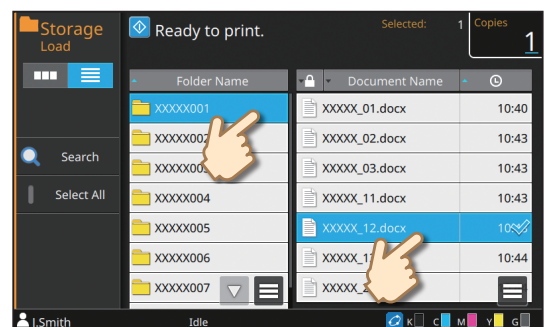

3 Press the [Start] key.

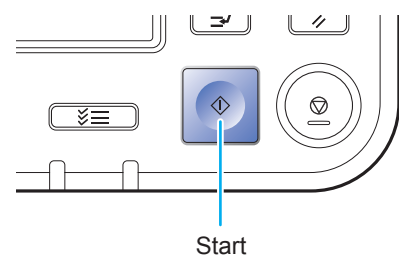

Using a USB Flash Drive

Saving Scanned Data to a USB Flash Drive

Scanned data will be saved in one of the following file formats: PDF, TIFF, or JPEG

1 Load the original and connect a USB flash drive to the machine.



You can use a USB flash drive compatible with Mass Storage Class and USB 2.0 or 3.0 specifications.

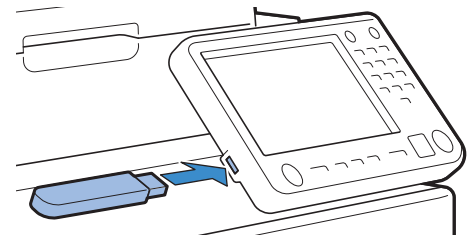

2 Touch [USB] - [Save] on the [Home1] screen.

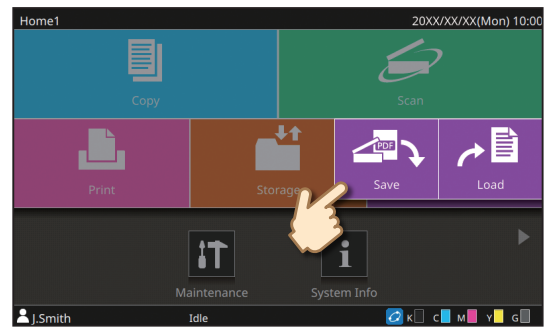

3 Select the destination folder and touch [Save Document].

You can change the settings.

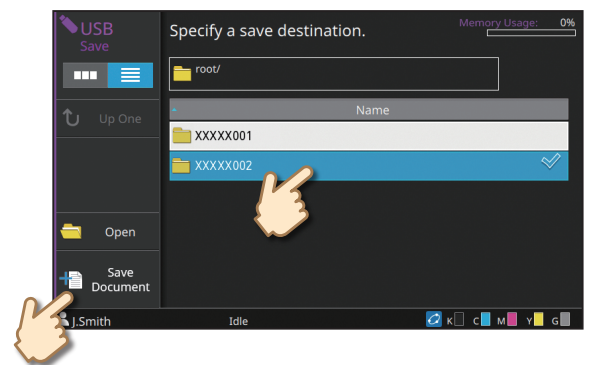

4 Press the [Start] key.

The data is saved to the USB flash drive.



Do not remove the USB flash drive until saving is finished.

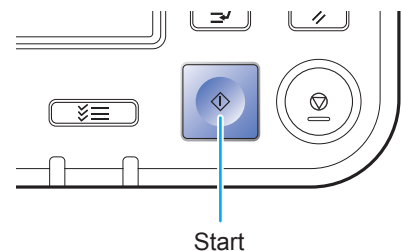

Printing Data from a USB Flash Drive

Print PRN files saved to a USB flash drive from the printer driver.

1 Connect a USB flash drive to the machine.

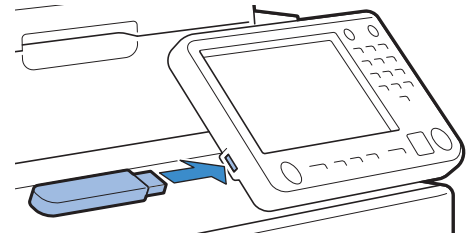

2 Touch [USB] - [Load] on the [Home1] screen.

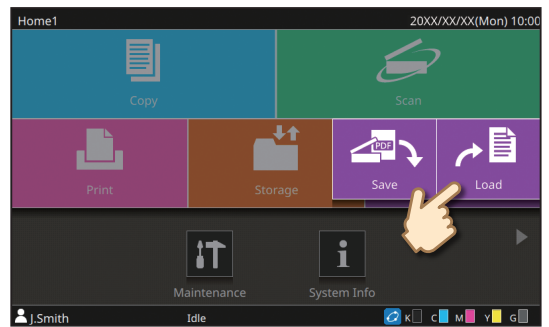

3 Open the folder that you want to load, and select the document.

Enter the number of copies using the numeric keys.

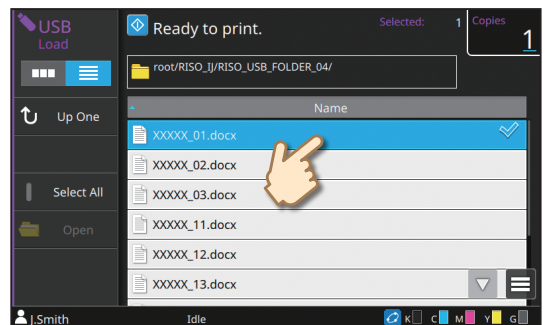

4 Press the [Start] key.

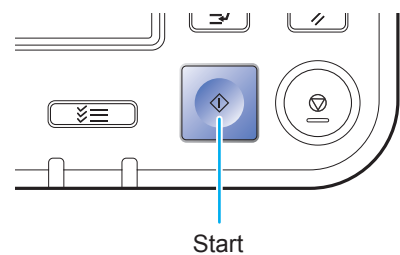

When Paper Runs Out

Loading Paper in the Feed Tray

We recommend loading plain paper in the feed trays.

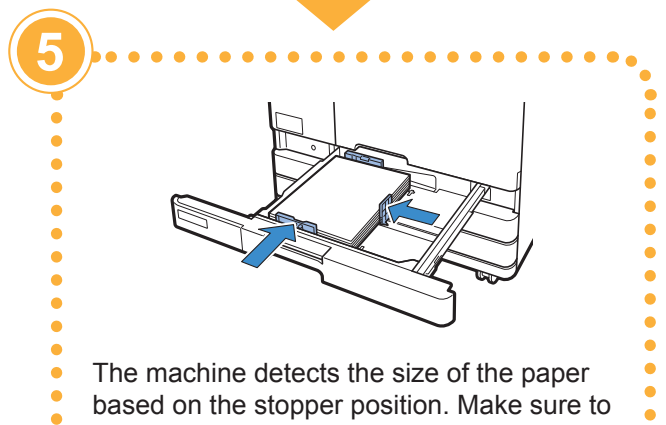
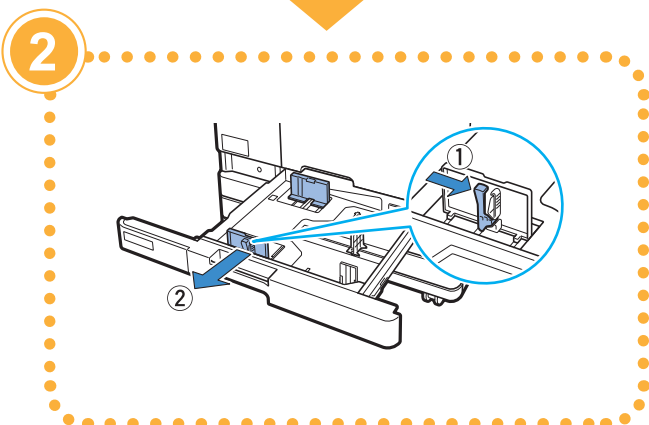
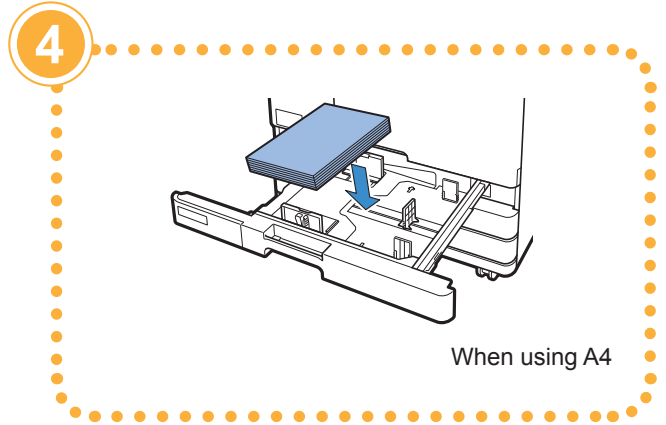
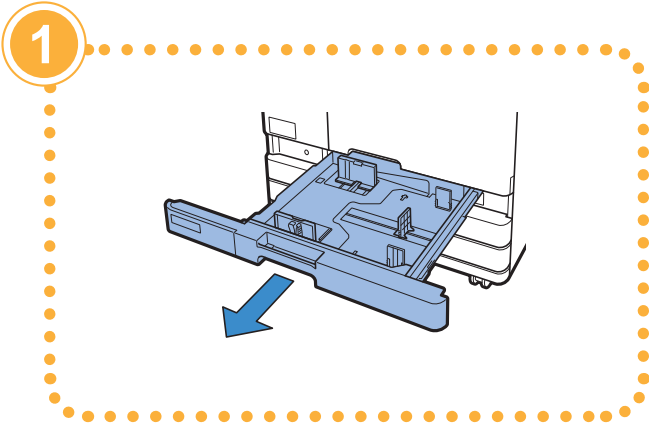

The machine detects the size of the paper based on the stopper position. Make sure to position the stopper against the edge of the paper.

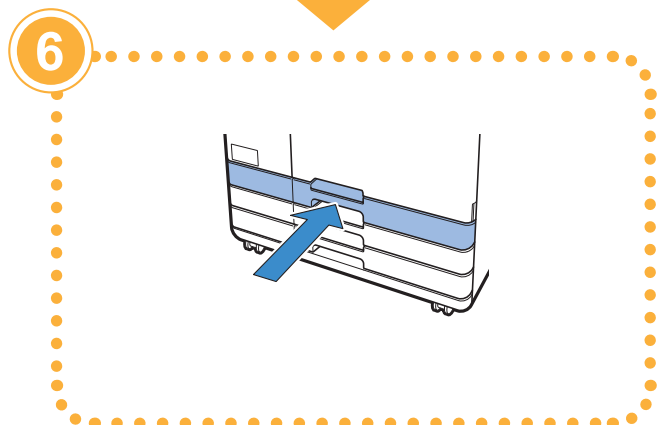
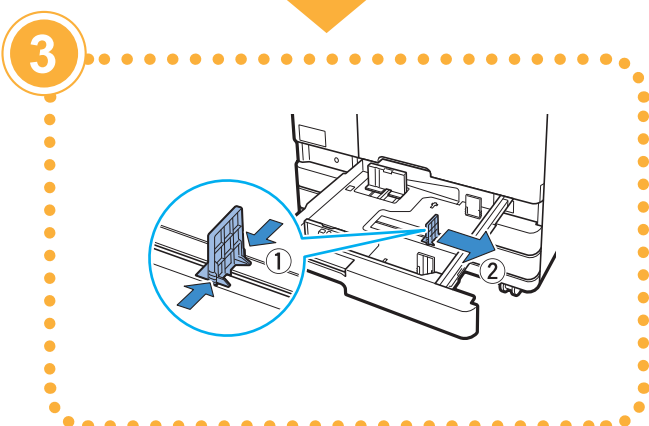

Loading Paper in the Standard Tray

Load thick paper and other special paper, postcards, or envelopes in the standard tray.

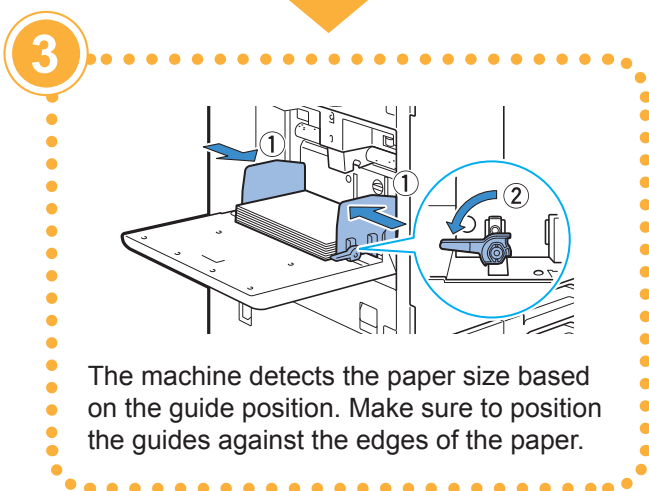
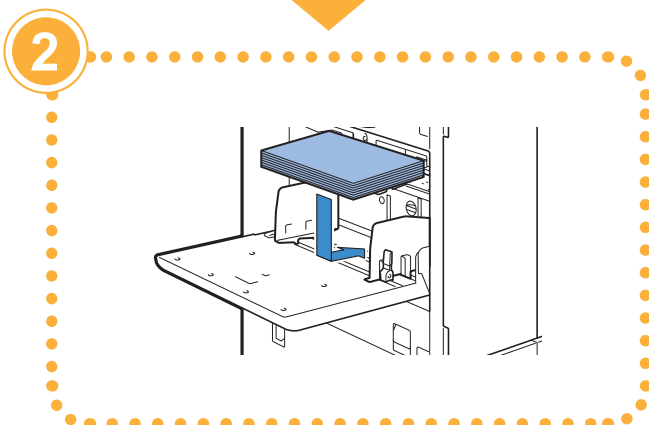
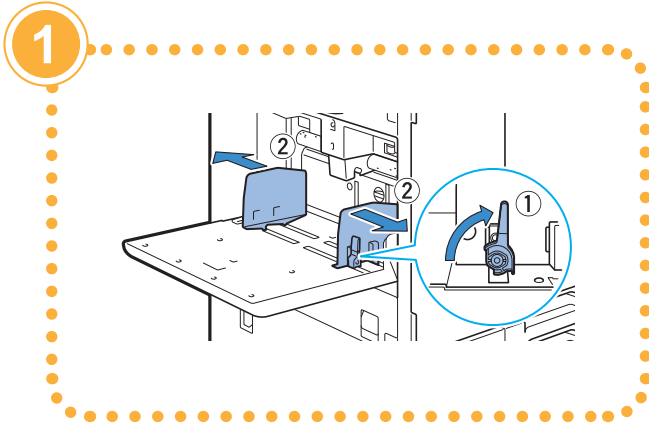

The machine detects the paper size based on the guide position. Make sure to position the guides against the edges of the paper.



Do Not Use These Paper Types

Using these paper types may cause problems such as paper jams.

- Paper that does not comply with the conditions in the basic specifications*
- Paper with a processed surface, such as thermal paper or carbon paper
- Curled paper (3 mm (1/8") or more)
- Paper with wrinkles
- Bent paper
- Torn paper
- Paper with ripples
- Coated paper such as art paper
- Paper with jagged edges
- Glued paper
- Paper with holes
- Gloss paper for photographs
- Transparencies
- Synthesized paper (Yupo)

* For more information on basic specifications, see the "User's Guide".

When Ink Runs Out

Replacing the Ink Cartridge

1

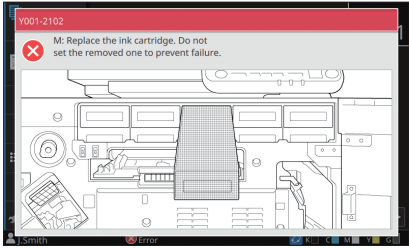

Printing stops and the message is displayed. Replace the cartridge of the color shown.

2

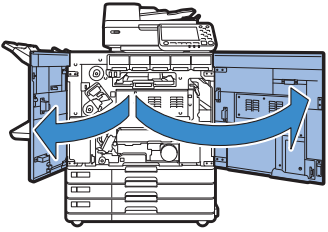

3

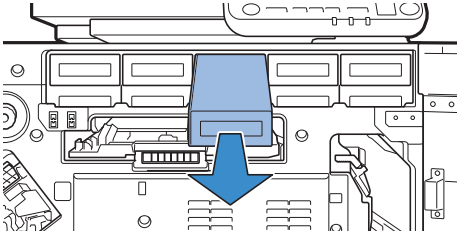

4

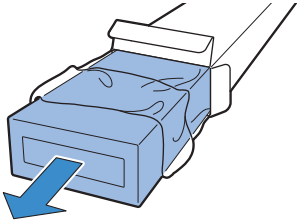

New ink cartridge

5

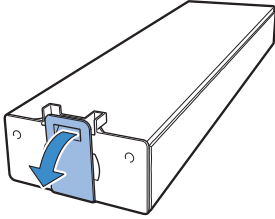

6



7



Handling the Ink Cartridge

Pay attention to the following when handling the ink cartridge.

CAUTION

- Avoid getting ink on your skin or in your eyes.
- Ensure adequate ventilation during printing.
- If you start to feel ill when using the machine, consult a physician immediately.



- We recommend using genuine RISO ink.
- Using ink other than RISO ink may prevent optimal printer performance. Malfunctions and reduced performance resulting from the use of non-RISO ink are not covered by the product warranty or service contract.
- Use the ink cartridge within 24 months from the date of manufacture (when preserved under room temperature). To maintain good printing quality, check the manufacture date and use soon after purchase. You can find the date of manufacture on the ink cartridge.
- Do not remove the ink cartridge until the ink replacement message is displayed.
- Do not shake the ink cartridge. Shaking will create air bubbles, which may prevent the ink from discharging properly and result in blurred printing.
- The ink cartridge is made from paper and plastic. Do not drop or damage it.
- Remove the ink cartridge from its plastic bag immediately before inserting it into the machine.
- Do not remove the ink cartridge cap until immediately before using the cartridge.
- After removing the ink cartridge cap, keep the ink supply outlet facing up. If the outlet faces down, ink may leak out.
- There may be ink on the area where you removed the protective cap. Do not touch it. Ink coming in contact with clothes will result in permanent stains.
- Do not attempt to refill the ink cartridge.
- In order to maintain optimal printing quality, take note of the date of manufacture and consume as soon as possible after purchase.

For additional precautions related to the ink cartridges, also see the "User's Guide".

Scanner Care

Periodically clean the scanner to ensure optimal image quality for copies and scans.

Foreign matter such as dust, dirt, ink, glue or correction fluid on the platen glass or white sheet of the ADF may reduce the quality of copies or scans.

Gently wipe the areas indicated below several times with a soft cloth.

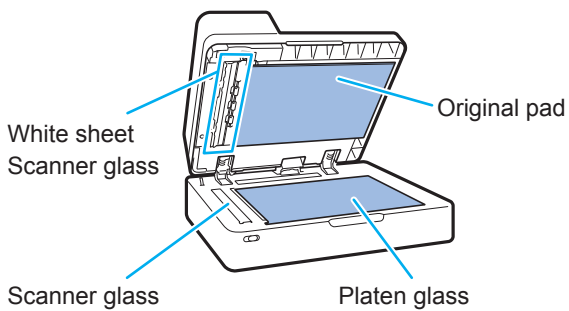

- Do not perform operations other than those described in this guide. To adjust or repair this machine, make sure to contact your dealer or authorized service representative.
- The platen glass is fragile. Never touch it with hard objects or expose it to impact.

Scanner Glass

If the scanner glass is dirty, black streaks may appear on copies and scans.

Wipe the scanner glass with a soft cloth.

Follow the procedure below when wiping the scanner glass on the top part of the scanner.

1

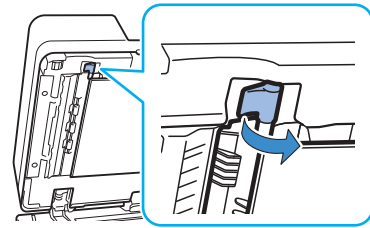

2

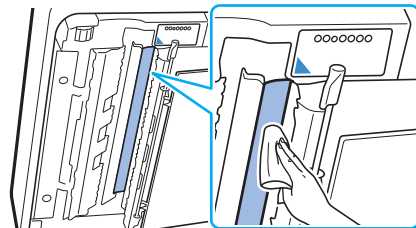

3

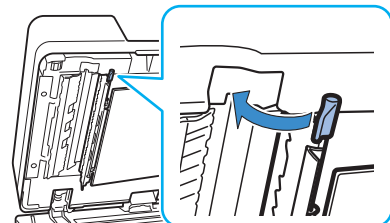



Useful Tips

Consumables

By touching [System Info] on the [Home1] screen, you can check the status of consumables such as remaining ink and the amount of paper left in the standard tray and paper tray.

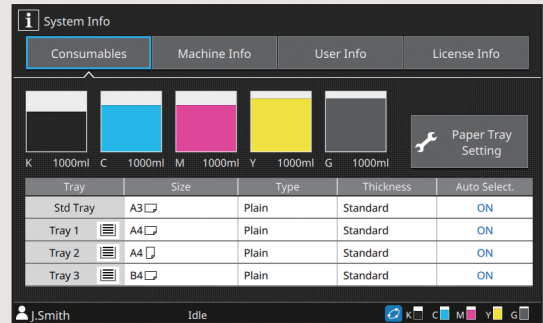

RISO Console

The RISO Console provides remote access to the machine via your computer's web browser, enabling you to check the machine's status and settings, as well as handle data, from a different location.

You can also check the status of consumables such as the ink and paper.

To use the RISO Console, make sure the machine has been connected to the network.

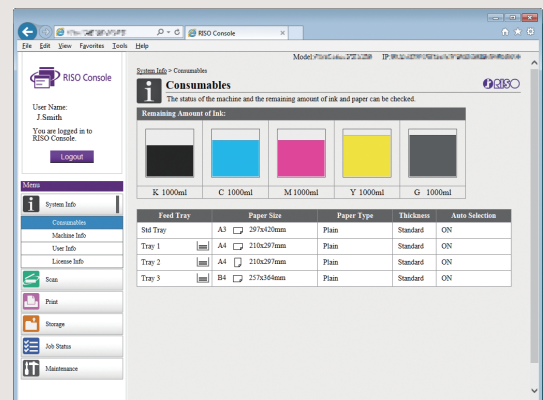

Cleaning the Print Head

The printed paper may have white streaks or appear blurry due to the clogged print head. Touch [Maintenance] – [Print Head Cleaning] on the [Home1] screen to unclog the print head. Normally, set [Normal Cleaning]. If this does not fix the problem, perform [Strong Cleaning].





Storing Consumables

● Paper Storage and Handling

- Always use paper from a sealed package.
- After you finish printing, remove the unused paper from the standard tray, place it back in the original package, and store it until you need it again. If you leave the paper in the standard tray, the paper may curl, causing a paper jam.
- If the paper is not cut very well or if the paper has a textured surface (such as drawing paper), fan the paper before use.
- Store the paper flat in a location that is not hot, humid, or exposed to direct sunlight.

● Storing Ink Cartridges

Because the ink cartridges are partially made of paper, they may become deformed and unusable if stored incorrectly or in an unsuitable environment. Store the ink cartridges correctly following the guidelines below.

- Store the ink cartridges in their original package, and make sure to keep them level with the "this side up" mark oriented properly.
- Avoid freezing and direct sunlight. Store in a location with a temperature between 5°C and 35°C (41°F and 95°F). Do not store in a location subject to extreme changes in temperature.
- When storing ink after removing it from the plastic bag, keep it in the orientation indicated on the cartridge and load it in the machine promptly.



Originals That May Not Be Copied

- **Do not use the equipment in any manner that violates the law or infringes on established copyrights, even when making copies for personal use. Consult your dealer or authorized service representative for further details. In general, use discretion and common sense.**
- **Do not use the machine to make copies of the following items.**
 - Copies of business-related documents, such as publicly issued stock certificates, drafts, and checks, other than copies required for business use
 - Copies of government-issued passports; motor vehicle licenses, permits, and personal identification documents issued by public or private organizations; and pass tickets, food tickets, and other tickets
 - Copies of copyrighted items, such as publications, music, works of art, prints, drawings, and photographs, other than for personal or household use

Trademark Credits

Microsoft and Windows are either registered trademarks or trademarks of Microsoft Corporation in the United States and/or other countries.

Mac, Mac OS, OS X, and Safari are trademarks of Apple Inc.

Adobe, the Adobe logo, PostScript, and PostScript 3 are either registered trademarks or trademarks of Adobe Systems Incorporated in the United States and/or other countries.

ColorSet is a trademark of Monotype Imaging Inc. registered in the U.S. Patent & Trademark Office and may be registered in certain jurisdictions.

FeliCa is a registered trademark of Sony Corporation.

Mifare is a registered trademark of Royal Philips Electronics.

 RISO, ComColor, and FORCEJET are trademarks or registered trademarks of RISO KAGAKU CORPORATION in the United States and other countries.

Other corporate names and/or trademarks are either registered trademarks or trademarks of each company, respectively.



As an ENERGY STAR® Partner, RISO KAGAKU CORPORATION has determined that this product meets the ENERGY STAR® guidelines for energy efficiency.



Acquisition of Color Universal Design Certification

The ComColor GD series (machine and optional equipment*) are certified for being manufactured in consideration of Color Universal Design, which improves visibility for more people regardless of individual differences in color perception, by the Color Universal Design Organization (CUDO).

* Certified optional equipment:

Scanner / Face down finisher / High capacity feeder / High capacity stacker



Please contact the following for supplies and service: